



## **WIPO IPAS**

Juneho Jang

Senior Regional Manager

# WIPO Systems

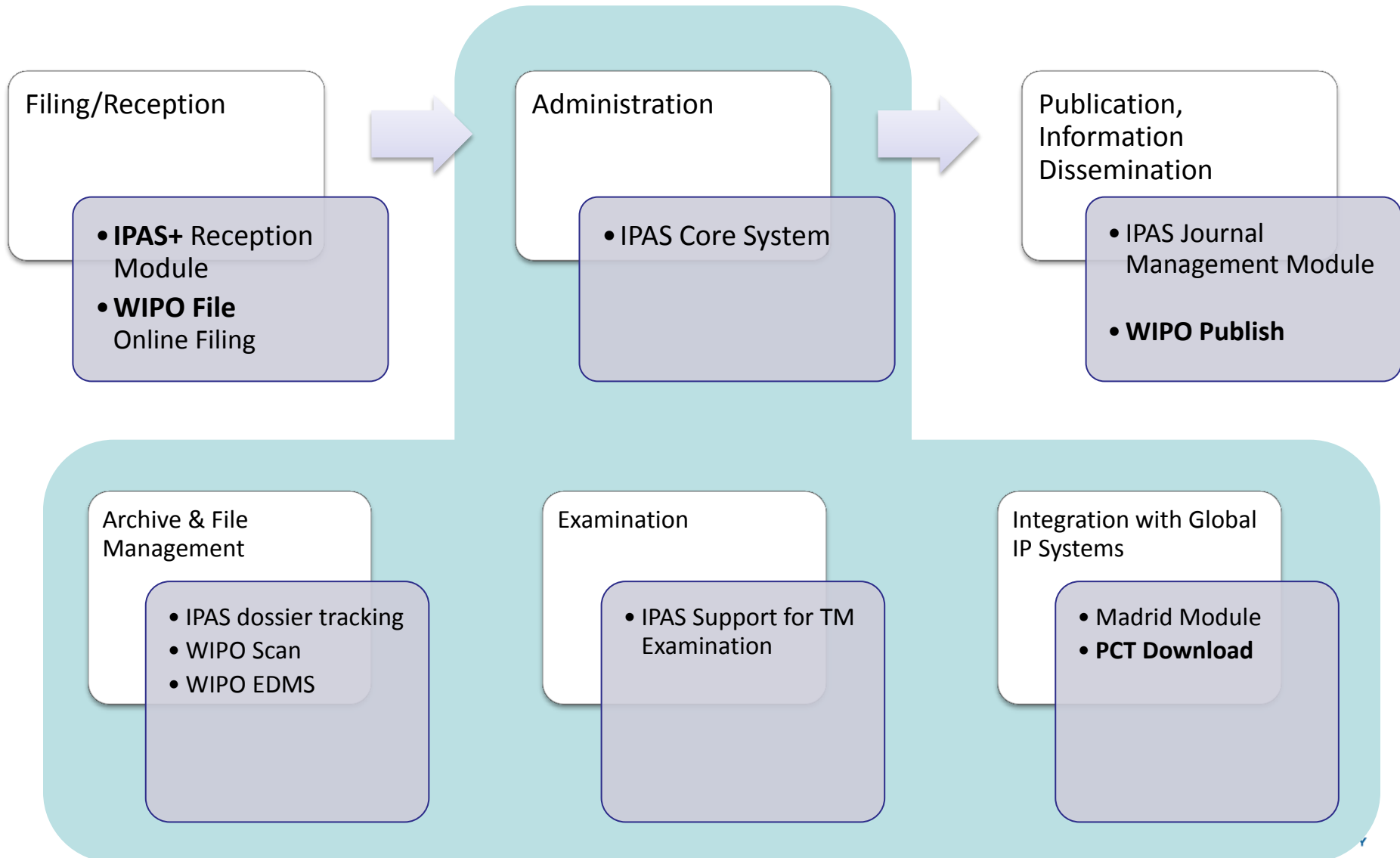

# IPAS

■ Industrial Property Automation System

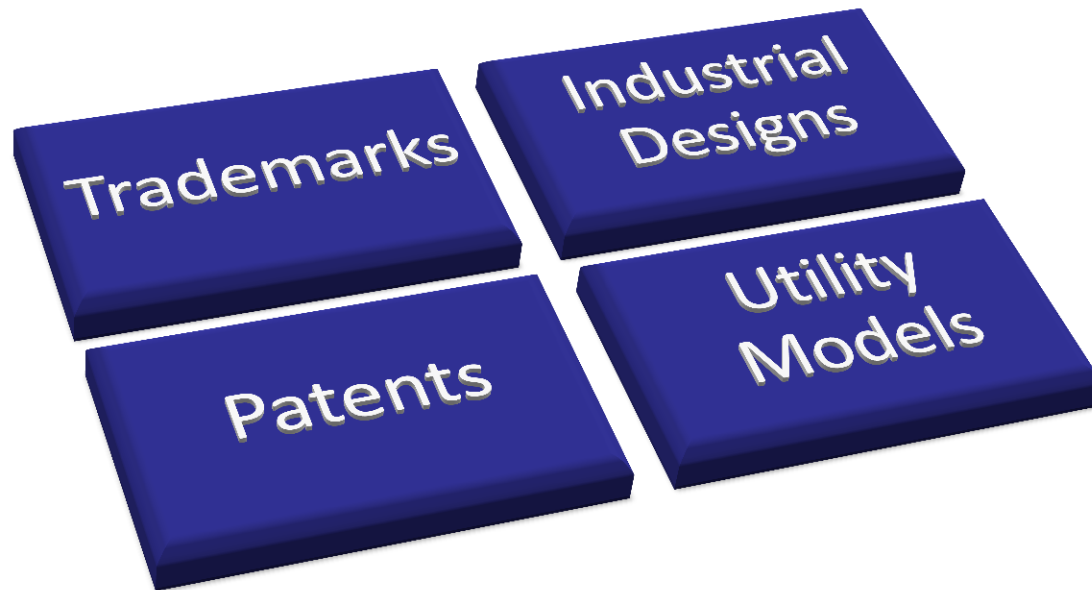



## ■ Applications

Configurable Application Types, Application Sub Types (Goods Mark, Service Mark, Domestic Mark, Foreign Mark, etc)



## ■ User Documents

Configurable User documents (Renewal, Change of Name/Address, Pre-application search, Opposition, Withdrawal request, Cancellation request, etc)



- Office Documents Templates  
Official letters, notifications, certificates



Data Capture



Registered



Substantive Examination

- Statuses

Classification Completed

(automatic) Publication of journal

Provisional Refusal Notification

DOC:Provisional Refusal

- Office Actions

# IPAS Workflow

- Statuses, Manual actions, Actions with time limits, Automatic actions, Actions with document outputs, Actions linked with User Documents

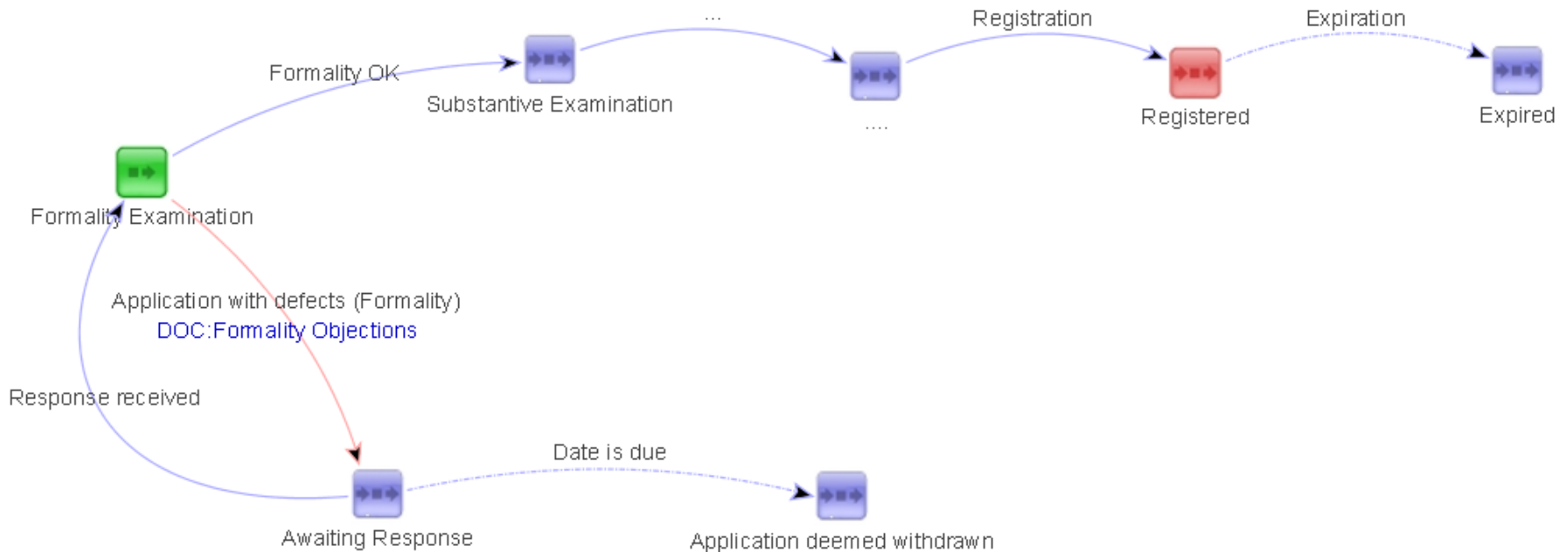

# IPAS Workflow

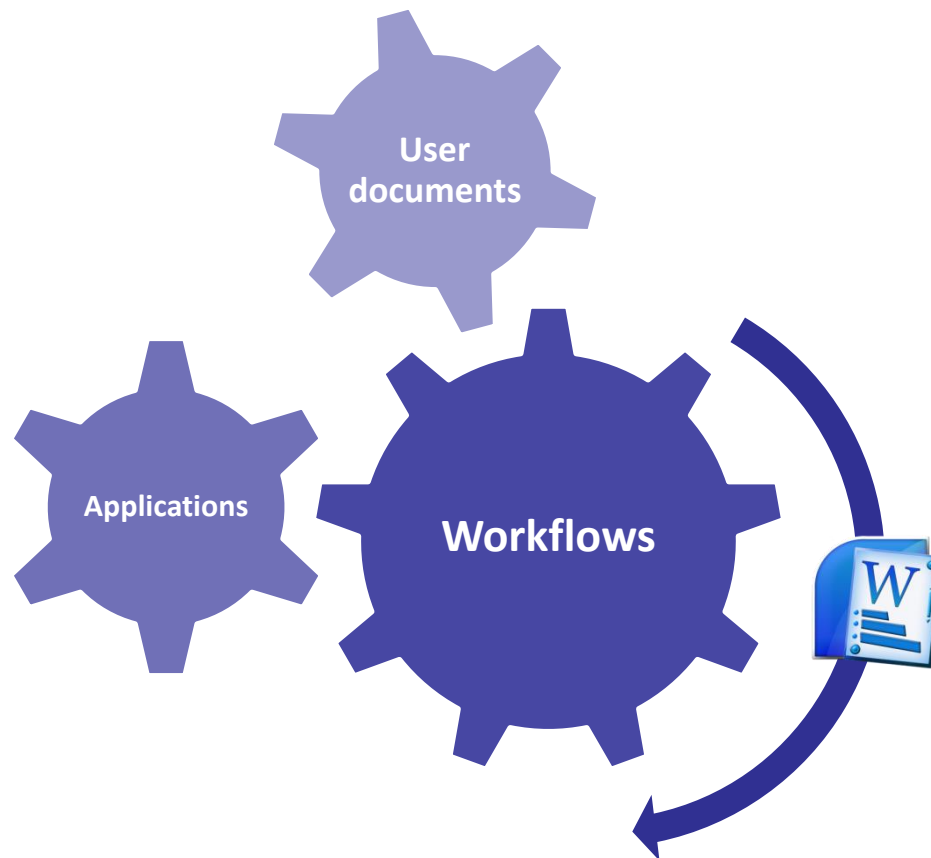

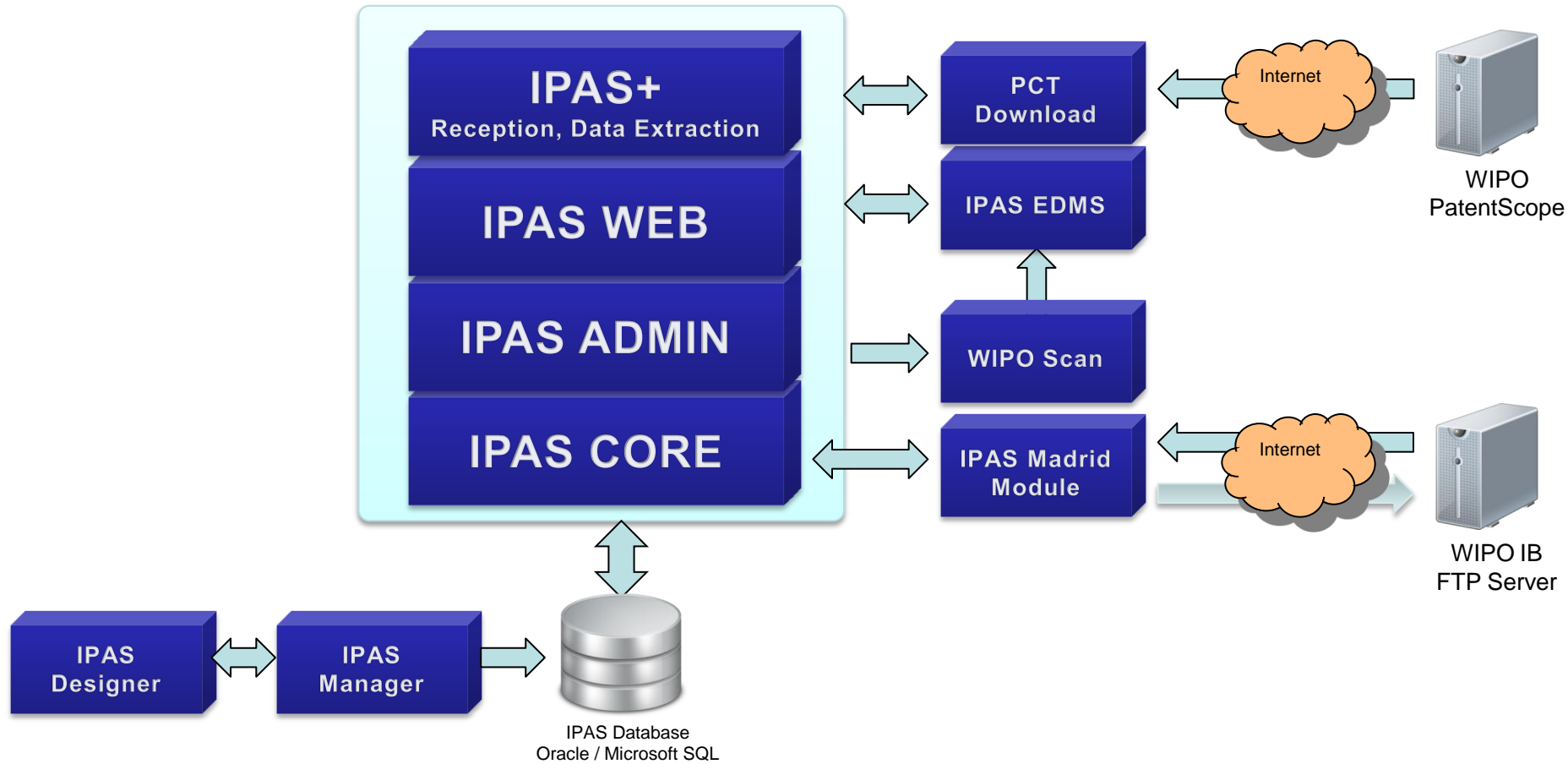





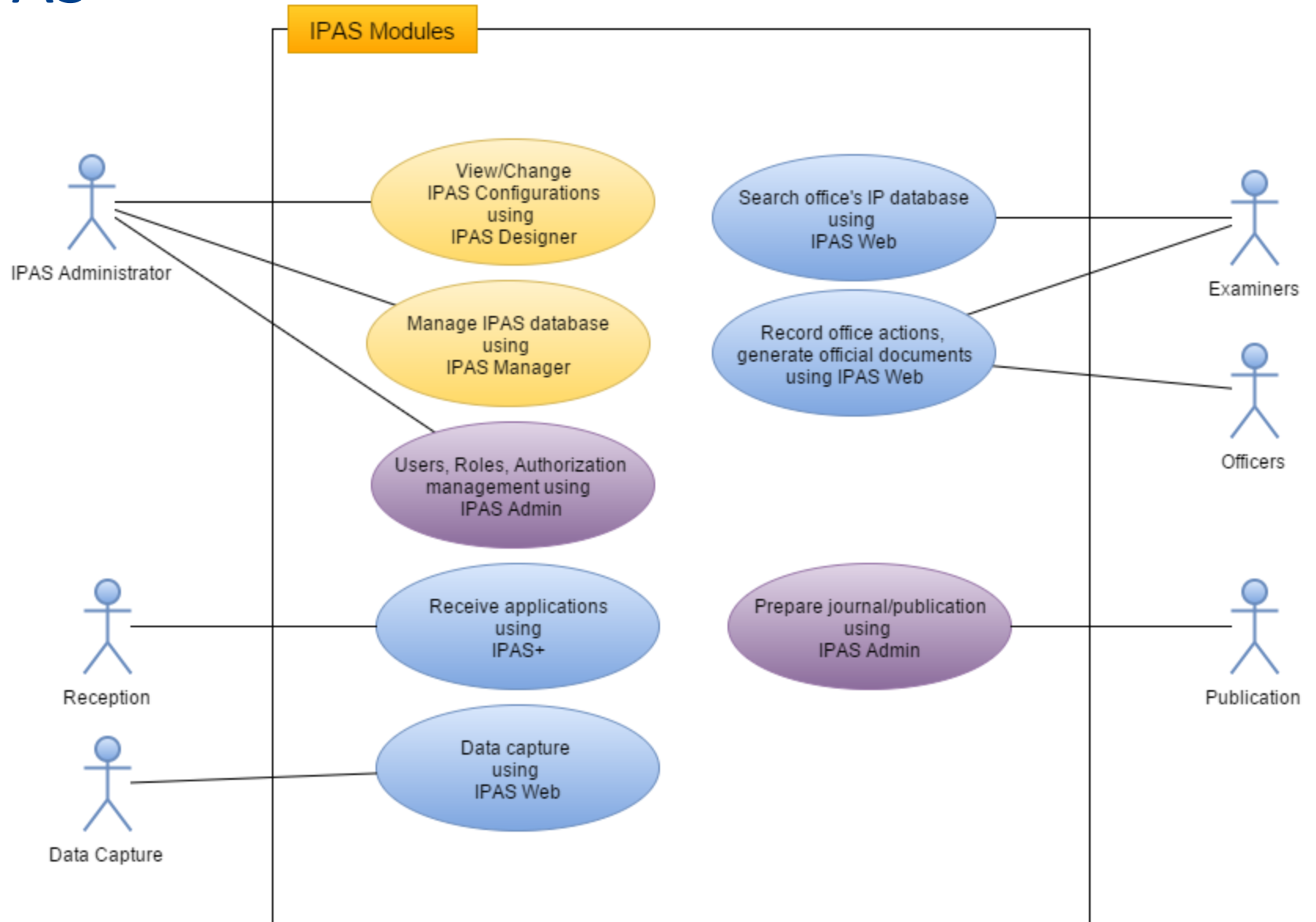







# IPAS









# Trademark Search

By Numbers	By Dates	By Person	By Mark	By Others
Mark Name Contains Word1			<input type="text"/>	
Mark Name Contains Word2			<input type="text"/>	
Mark Name Contains Word3			<input type="text"/>	
Mark Name Contains Word4			<input type="text"/>	
Mark Name Contains Word5			<input type="text"/>	
Mark Full Name			<input type="text"/>	
Nice Class Edition			<input type="text"/>	
List Of Nice Classes			<input type="text"/>	
List Of National Classes			<input type="text"/>	
Include Reclassified Classes			<input checked="" type="checkbox"/>	
Sign Type			<input type="text"/>	
Application Type			<input type="text"/>	
Application Subtype			<input type="text"/>	
Logo Description Contains Word1			<input type="text"/>	
Logo Description Contains Word2			<input type="text"/>	
Logo Description Contains Word3			<input type="text"/>	
Search Words			<input type="text"/>	
In Mark Translation			<input type="checkbox"/>	
In Mark Transliteration			<input type="checkbox"/>	
In All Of Above			<input type="checkbox"/>	

By Numbers	By Dates	By Person	By Mark	By Others
File Number			<input type="text"/>	
File Nbr Range			<input type="text"/>	<input type="text"/>
Registration Type			<input type="text"/>	
Registration Series			<input type="text"/>	
Registration Nbr			<input type="text"/>	
Registration Number Range			<input type="text"/>	<input type="text"/>
Receipt Nbr			<input type="text"/>	
External System Id			<input type="text"/>	

By Numbers	By Dates	By Person	By Mark	By Others
Filing Date			<input type="text"/>	
Filing Date Range			<input type="text"/>	 <input type="text"/> 
Reception Date Range			<input type="text"/>	 <input type="text"/> 
Novelty Date From			<input type="text"/>	 <input type="text"/> 
Registration Date Range			<input type="text"/>	 <input type="text"/> 
Expiration Date Range			<input type="text"/>	 <input type="text"/> 

# Trademark Module

File No.	Logo	Novelty date	Mark name	Classes	Owner name	Status
<input type="checkbox"/> PG/M/0001/070299		Prio: 10/02/2012 File: 01/03/2012	DENSO	NCL(0) 2	Winn & Coales International Limited [UK]	Objected, awaiting response
<input type="checkbox"/> PG/M/0001/070242		13/02/2012		NCL(0) 7	ENERFLEX LIMITED [CA]	To be published
<input type="checkbox"/> PG/M/0001/070243		13/02/2012		NCL(0) 35	ENERFLEX LIMITED [CA]	Objected, awaiting response
<input type="checkbox"/> PG/M/0001/070244		13/02/2012	GAS DRIVE	NCL(0) 7	ENERFLEX LIMITED [CA]	To be published
<input type="checkbox"/> PG/M/0001/070245		13/02/2012	GAS DRIVE	NCL(0) 35	ENERFLEX LIMITED [CA]	Objected, awaiting response
<input type="checkbox"/> PG/M/0001/070257		14/02/2012	TITAN MINING SERVICES	NCL(0) 42	Titan International, Inc. [US]	Substantive examination
<input type="checkbox"/> PG/M/0001/070255		14/02/2012	RE/MAX	NCL(0) 36	RE/MAX, LLC [US]	Substantive examination
<input type="checkbox"/> PG/M/0001/070246		14/02/2012	NICHIHA	NCL(0) 6	Nichiha Corporation [JP]	Objected, awaiting response

# Trademark Module

(219) Application Nbr	PG/M/0001/070244																		
Status	To be published																		
Last action	Acceptance																		
Application type	Part A																		
Sign type	Both name and logo																		
(541) Mark name	GAS DRIVE																		
(540) Mark image																			
Colour description	-																		
Vienna classes	<table border="1"> <thead> <tr> <th>Category</th> <th>Division</th> <th>Section</th> <th>Description</th> </tr> </thead> <tbody> <tr> <td>24</td> <td>15</td> <td>17</td> <td>Arrows formed by an inscription</td> </tr> <tr> <td>24</td> <td>15</td> <td>21</td> <td>Arrowheads</td> </tr> </tbody> </table>			Category	Division	Section	Description	24	15	17	Arrows formed by an inscription	24	15	21	Arrowheads				
Category	Division	Section	Description																
24	15	17	Arrows formed by an inscription																
24	15	21	Arrowheads																
(512) Nice class(es)	<table border="1"> <thead> <tr> <th>Ed</th> <th>Nbr</th> <th>Status</th> <th>Description</th> </tr> </thead> <tbody> <tr> <td>0</td> <td>7</td> <td>Pending</td> <td>Spark ignited engines; internal combustion engines for mechanical drive and power; Replacement parts for internal combustion engines, compressors and mechanical drives in Class 7.</td> </tr> </tbody> </table>			Ed	Nbr	Status	Description	0	7	Pending	Spark ignited engines; internal combustion engines for mechanical drive and power; Replacement parts for internal combustion engines, compressors and mechanical drives in Class 7.								
Ed	Nbr	Status	Description																
0	7	Pending	Spark ignited engines; internal combustion engines for mechanical drive and power; Replacement parts for internal combustion engines, compressors and mechanical drives in Class 7.																
(730) Owner(s)	<table border="1"> <thead> <tr> <th>Name</th> <th>Id nbr</th> <th>Street</th> <th>City</th> <th>State</th> <th>ZIP</th> <th>Country</th> <th>Ownership notes</th> </tr> </thead> <tbody> <tr> <td>ENERFLEX LIMITED</td> <td></td> <td>Suite 904, 1331 MacLeod Trail S.E., Calgary, Alberta, T2B 3R1</td> <td></td> <td></td> <td></td> <td>CA</td> <td></td> </tr> </tbody> </table>			Name	Id nbr	Street	City	State	ZIP	Country	Ownership notes	ENERFLEX LIMITED		Suite 904, 1331 MacLeod Trail S.E., Calgary, Alberta, T2B 3R1				CA	
Name	Id nbr	Street	City	State	ZIP	Country	Ownership notes												
ENERFLEX LIMITED		Suite 904, 1331 MacLeod Trail S.E., Calgary, Alberta, T2B 3R1				CA													
Reception date	13/02/2012 15:15:00																		
(220) Filing date	13/02/2012 15:15:00																		
(740) Representative	<table border="1"> <thead> <tr> <th>Name</th> <th>Id nbr</th> <th>Street</th> <th>City</th> <th>State</th> <th>ZIP</th> <th>Country</th> </tr> </thead> <tbody> <tr> <td>ASHURST - PNG</td> <td></td> <td>P O Box 850, Port Moresby, National Capital District</td> <td></td> <td></td> <td></td> <td>PG</td> </tr> </tbody> </table>			Name	Id nbr	Street	City	State	ZIP	Country	ASHURST - PNG		P O Box 850, Port Moresby, National Capital District				PG		
Name	Id nbr	Street	City	State	ZIP	Country													
ASHURST - PNG		P O Box 850, Port Moresby, National Capital District				PG													
Notes	Trademark is to be registered as Series Trademark																		

Events	Status	Frozen By	Freezing	
Type	Date	Description	Notes	Action 1
e-doc	13/02/2012	App: Trade Mark	No content yet	
Action	15/02/2012	Notification of lodgement	Delivered (21/02/2012) .	<a href="#">Details</a>
Action	23/03/2012	Recommendation for acceptance		<a href="#">Details</a>
Action	03/04/2012	Acceptance	Mailed (16/04/2012) .	<a href="#">Details</a>

# Patent Module

Selected	File id	Novelty date	Reg Nbr	Application subtype	Title	Classes	Owner	Status	Responsible
<input type="checkbox"/>	<a href="#">PG/P/2009/000028</a>	20/09/2007 15/07/2009		PCT	A PLANT ROOT SYSTEM IMPROVING COMPOSITION	A 01N 25/00, 25/08, 25/12	MALAYSIAN AGRICULTURE HI-TECH SDN BHD [MY]	Examination	
<input type="checkbox"/>	<a href="#">PG/P/2009/000029</a>	11/01/2008 20/07/2009		PCT	PROCESSES FOR PRODUCTION OF LIQUID FUEL	C 10G 45/02, 45/62, 47/18, 65/16	NIPPON OIL CORPORATION [JP]	Due Date Lapsed examination	
<input type="checkbox"/>	<a href="#">PG/P/2009/000030</a>	18/03/2008 22/07/2009		PCT	PROCESS AND PLANT FOR PRODUCING METAL OXIDE FROM METAL SALTS	B 01J 8/24, C 01B 13/18, C 01F 7/44	OUTOTEC OYJ [FI]	PA Withdrawn	
<input type="checkbox"/>	<a href="#">PG/P/2009/000031</a>	20/12/2007 22/07/2009		PCT	A SYSTEM AND METHOD FOR ORIENTATING SCAN CLOUD DATA RELATIVE TO BASE REFERENCE DATA	G 01B 11/10, 11/30, G 06T 17/40	SCANALYSE PTY LTD [AU]	Examination	
<input type="checkbox"/>	<a href="#">PG/P/2009/000032</a>	07/02/2008 28/07/2009		PCT	FLOW CONTROL VALVE	F 16K 01/12, 31/08, 31/54	MOKVELD VALVES B.V. [NL]	Grant recommended	
<input type="checkbox"/>	<a href="#">PG/P/2009/000033</a>	25/01/2008 14/08/2009		PCT	METHOD AND SYSTEM FOR REMOVING MANGANESE FROM WASTE LIQUORS	C 02F 01/52, 01/58, 01/66, 01/72, 09/04	VALE INCO LIMITED [CA]	Due Date Lapsed examination	
<input type="checkbox"/>	<a href="#">PG/P/2009/000034</a>	28/01/2008 14/08/2009		PCT	HYDROCARBON GAS PROCESSING	F 25J 03/00	ORTLOFF ENGINEERS LTD [US]	Due Date Lapsed examination	
<input type="checkbox"/>	<a href="#">PG/P/2009/000035</a>	01/03/2007 01/09/2009		PCT	HIGH PERFORMANCE GEOSYNTHETIC ARTICLE	C 08L 23/00	PRS MEDITERRANEAN LTD [IL]	Grant recommended	
<input type="checkbox"/>	<a href="#">PG/P/2009/000036</a>	29/01/2008 11/09/2009		PCT	PROCESS FOR PRODUCTION OF HYDROCARBONS BY REDUCTION OF CARBON MONOXIDE	B 01J 23/75, C 07C 1/04, C 10G 2/00	NIPPON OIL CORPORATION [JP]	Waiting for response to exam. request	
<input type="checkbox"/>	<a href="#">PG/P/2009/000037</a>	10/04/2008 15/09/2009		PCT	PYRIMIDINYL-PIPERAZINES USEFUL AS DOPAMINE D3/D2 RECEPTOR LIGANDS	A 61K 31/506, A 61P 25/00, C 07D 239/48	RICHTER GEDEON NYRT [HU]	Accordance of filing date	
<input type="checkbox"/>	<a href="#">PG/P/2009/000038</a>	18/09/2009		National	OIL PALM FRUIT PROCESSING PLANT	A 23B 4/005, 7/026, A 23D 9/05	MALAYSIAN PALM OIL BOARD [MY]	Due Date Lapsed examination	
<input type="checkbox"/>	<a href="#">PG/P/2009/000039</a>	19/02/2008 18/09/2009		PCT	APPARATUS AND METHOD FOR OPTIMIZING A LIQUEFIED NATURAL GAS FACILITY		HONEYWELL INTERNATIONAL INC. [US]	Due Date Lapsed examination	
<input type="checkbox"/>	<a href="#">PG/P/2009/000040</a>	19/03/2008 28/09/2009		PCT	METHODS OF PRODUCING HAPLOID AND DOUBLED HAPLOID OIL PALMS	A 01H 1/04, 5/00, C 12Q 1/68	SUMATRA BIOSCIENCE PTE. LTD. [SG]	Due date lapsed	
<input type="checkbox"/>	<a href="#">PG/P/2009/000041</a>	05/05/2008 20/10/2009		PCT	CATALYSTS	B 01J 23/75, 37/18, C 10G 2/00	SASOL TECHNOLOGY (PROPRIETARY) LIMITED [ZA]	Examination	
<input type="checkbox"/>	<a href="#">PG/P/2009/000042</a>	27/08/2007 27/10/2009		PCT	MUTAGENIZED TOBACCO PLANT AS SEED CULTURE FOR THE PRODUCTION OF OIL FOR ENERGETIC, INDUSTRIAL AND ALIMENTARY USES	A 01H 1/06, C 12N 15/82	AEP ADVANCED ECOPOWER PATENTS SA [CH]	Due Date Lapsed examination	

# Patent Module

Application type	PCT
(219) Application Nbr	PG/P/2009/000032
(51)IPC	F 16K 01/12, 31/08, 31/54
Reception date	28/07/2009
(220) Filing date	28/07/2009
Novelty date	07/02/2008
(30)Priority	DE 102007007664.0 13/02/2007 Pending;
Status	Grant recommended
(71) Applicant	MOKVELD VALVES B.V., Nijverheidstraat 67, NL-2802 JE Gouda (NL) [NL];
Inventor	Esveldt, Vincent, Anna van Hensbeeksingel 145, NL-2803 LS Gouda (NL) [NL];
(740) Representative	PHILIPS ORMONDE FITZPATRICK, C/DFK - HILLMAYBERRY, P.O BOX 1829, PORT MORESBY, NATIONAL CAPITAL DISTRICT [PG];
(54)Title	FLOW CONTROL VALVE
English title	

Drawing

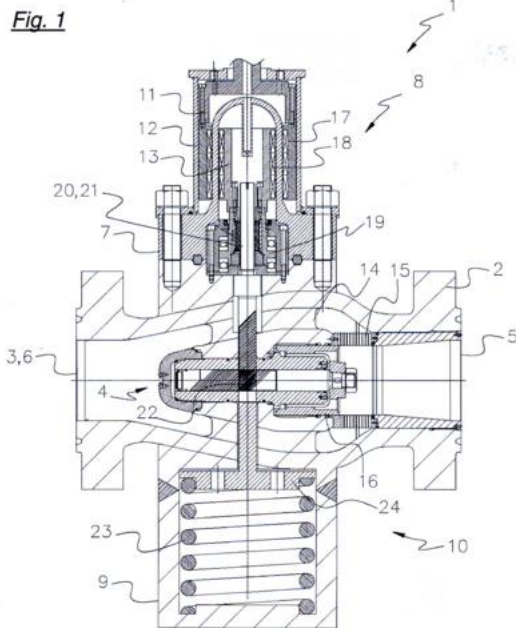

(57)Abstract

Disclosed is a throttle valve (1) having a housing (2) comprising an inlet opening (3) for a fluid, a rotatable shaft (13), and a piston (16), which is axially movable within the housing (2). The axial movement of the piston (16) a throttle cross section of the throttle (4) can be adjusted. For large pipe cross-sections the throttle valve according to the invention is improved, so that the axial movement of the piston (16) a throttle cross section of the throttle (4) can be adjusted. For large pipe cross-sections the throttle valve according to the invention is improved, so that the axial movement of the piston (16) a throttle cross section of the throttle (4) can be adjusted. For large pipe cross-sections the throttle valve according to the invention is improved, so that the axial movement of the piston (16) a throttle cross section of the throttle (4) can be adjusted.

English abstract

Notes

24/02/2012 - Claim amended to confirm to New Zealand Patent no: 578375

# Industrial Design Module

Selected	File id	Novelty date	Reg Nbr	Application subtype	Title	Classes	Owner	Status	Responsible
<input type="checkbox"/>	PG//2007/000003	12/07/2007	21	Industrial Designs	WISHBONE CONTAINER (1 LITRE)		SHELL INTERNATIONAL PETROLEUM COMPANY LIMITED [UK]	Granted	
<input type="checkbox"/>	PG//2007/000004	12/07/2007		Industrial Designs	VIGOR CONTAINER (ONE LITRE).		SHELL INTERNATIONAL PETROLEUM COMPANY LIMITED [UK]	PA Withdrawn	
<input type="checkbox"/>	PG//2007/000005	06/09/2007	12	Industrial Designs	SOCKET PLUG		CLIPSAL AUSTRALIA PTY LTD [AU]	Granted	
<input type="checkbox"/>	PG//2007/000006	06/09/2007	13	Industrial Designs	SOCKET PLUG TOOL.		CLIPSAL AUSTRALIA PTY LTD [AU]	Granted	
<input type="checkbox"/>	PG//2008/000001	05/02/2008	14	Industrial Designs	A BOTTLE		V & S VIN AND SPIRIT AKTIEBOLAG (PUBL) [SE]	Granted	
<input type="checkbox"/>	PG//2008/000002	05/02/2008	15	Industrial Designs	A BOTTLE.		V&S VIN & SPRIT AKTIEBOLAG (PUBL) [SE]	Granted	
<input type="checkbox"/>	PG//2008/000003	01/04/2008	16	Industrial Designs	THIS PRODUCT IS PUT ON AN INDOOR FLOOR AND THE GROUND FOR USE.		KUNIAKI TAKAMATSU [JP]	Granted	
<input type="checkbox"/>	PG//2008/000004	03/04/2008	17	Industrial Designs	INCINERATOR DESIGN.		ATPROJECTS INC. [PG]	Granted	
<input type="checkbox"/>	PG//2008/000005	28/05/2008	18	Industrial Designs	CABLE MANAGEMENT RACK COVER		CLIPSAL AUSTRALIA PTY LTD [AU]	Granted	Stafford Kibby
<input type="checkbox"/>	PG//2008/000006	14/08/2008		Industrial Designs	BRACELET		KUNIAKI TAKAMATSU [JP]	Waiting publication/grant fees	
<input type="checkbox"/>	PG//2009/000001	06/11/2009	23	Industrial Designs	SENSOR DATA COLLECTOR MOTE		MIMOS BERHAD [MY]	Granted	
<input type="checkbox"/>	PG//2009/000002	06/11/2009	22	Industrial Designs	SENSOR MOTE		MIMOS BERHAD [MY]	Granted	
<input type="checkbox"/>	PG//2010/000001	15/10/2010		Industrial Designs	BOTTLE		Fraser and Neave Limited [SG]	Grant recommended	
<input type="checkbox"/>	PG//2011/000002	28/01/2011		Industrial Designs	PICKET		FSP HOLDINGS PTY LTD [AU]	Accordance of filing date	
<input type="checkbox"/>	PG//2011/000003	01/09/2011		Industrial Designs	100 PLUS BOTTLE		FRASER AND NEAVE, LIMITED [SG]	Grant recommended	

# Industrial Design Module

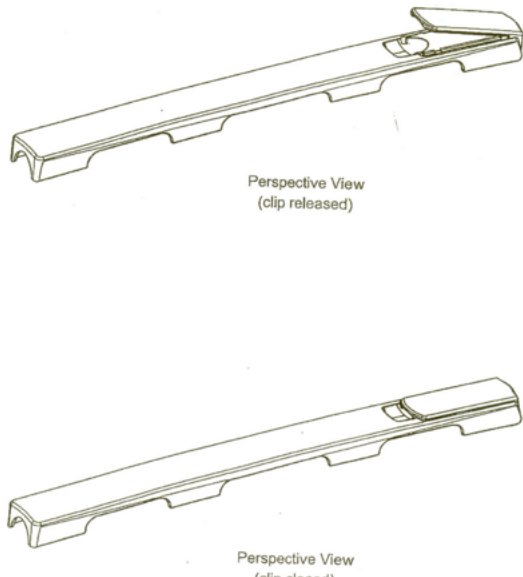
Application type	Industrial Designs
(219) Application Nbr	PG//2008/000005
Locarno	8-8;
Reception date	28/05/2008
(220) Filing date	28/05/2008
Novelty date	28/05/2008
Status	Granted
Publication	24/09/2009 Journal: 2009/67
(111) Registration Nbr	18
Registration date	22/09/2008
Entitlement date	28/05/2008
(141) Expiration date	28/05/2013
(71) Applicant	CLIPSAL AUSTRALIA PTY LTD, 12 Park Terrace, Bowden
Inventor	Kenneth Basil Gransbury, 14 Gurr's Road, Kensington Park
(740) Representative	GADENS LAWYERS, P O BOX 1042, PORT MORESBY, NATIONAL CAPITAL DISTRICT (P.O.)
(54) Title	CABLE MANAGEMENT RACK COVER
English title	
Drawing	 <p>Perspective View (clip released)</p> <p>Perspective View (clip closed)</p>

Events	Status	Frozen By	Freezing	
Type	Date	Description	Notes	
e-doc	28/05/2008	App: Industrial Designs	No content yet	
Action	06/08/2008	PA Acknowledgement of receipt	Awaiting manual delivery (06/08/2008) .	
Action	16/06/2009 24/09/2009 Journal	PA Formalities OK		
Action	16/06/2009	PA Examination requests	Awaiting manual delivery (18/05/2012) .	
Action	16/06/2009	PA Response to examination request		
Action	16/06/2009	PA Grant recommended		
Action	16/06/2009	PA Send request for granting fees	Awaiting manual delivery (18/05/2012) .	
Action	16/06/2009 24/09/2009 Journal	PA Fees received/Grant	Awaiting manual delivery (18/05/2012) .	
Action	16/06/2009	PA Patent certificate	Awaiting manual delivery (18/05/2012) .	



# Number of Applications by Statuses

1, 2, 3

Process type	Status	User	Quantity	Avg days old	Min days old	Max days old
Marks	Analysing if oppositions were filed		137	1325	1310	1784
Marks	Approving acceptance		9	1257	1249	1309
Marks	Approving refusal		95	3082	2272	3102
Marks	Awaiting oppositions		157	1309	1309	1309
Marks	Awaiting registration fee		84	1290	1281	1301
Marks	Cancelled		49	3703	1288	7734
Marks	Confirming lapsing		45	1901	1440	2231
Marks	Confirming refusal for non-response		3	1267	1260	1279
Marks	Controlling registration fee		10	2458	1255	3096
Marks	Data Capture		21	7323	14	14650
Marks	Formality Examination		1	0	0	0
Marks	Lapsed		390	2945	1511	8119
Marks	Migrated		5	7978	4324	13043
Marks	Objected, awaiting response		221	1341	1248	1427
Marks	Objected, awaiting response (first reminder)		41	1279	1252	1336
Patents	Accordance of filing date		169	1680	1260	2812
Patents	Awaiting AUS response	Stafford Kibby	1	1424	1424	1424
Patents	Awaiting AUS response		5	1424	1424	1425
Patents	Due Date Lapsed examination		48	1656	1277	2272
Patents	Due date lapsed		3	1419	1305	1573
Patents	Examination		36	1717	1335	2467
Patents	Grant recommended		12	1469	1340	1656
Patents	Granted	Stafford Kibby	1	2323	2323	2323
Patents	Granted		58	2274	1337	3021
Patents	Granted Certificate to be printed		3	1569	1476	1756
Patents	Objected (formalities)		9	1358	1349	1389
Patents	PA Lapsed		4	2210	2068	2323

# Recording Office Action

File Number

	File id	File Id Logo	Filing date	Reg Nbr	Description	Classes	Owner	Status
<input type="checkbox"/>	PG/M/0001/070342		13/03/2012		TAKEDA	10	TAKEDA PHARMACEUTICAL COMPANY LIMITED [JP]	Formality Examination

Action Type \*

Action Date \*

Notes

Application with Formality Defects 1

Formality Checking Completed 2

Withdrawal 3

1

	File id	File Id Logo	Filing date	Reg Nbr	Description	Classes	Owner	Status
<input type="checkbox"/>	PG/M/0001/070342		13/03/2012		TAKEDA	10	TAKEDA PHARMACEUTICAL COMPANY LIMITED [JP]	Awaiting Formality Completion

2

	File id	File Id Logo	Filing date	Reg Nbr	Description	Classes	Owner	Status
<input type="checkbox"/>	PG/M/0001/070342		13/03/2012		TAKEDA	10	TAKEDA PHARMACEUTICAL COMPANY LIMITED [JP]	Substantive Examination

3

	File id	File Id Logo	Filing date	Reg Nbr	Description	Classes	Owner	Status
<input type="checkbox"/>	PG/M/0001/070342		13/03/2012		TAKEDA	10	TAKEDA PHARMACEUTICAL COMPANY LIMITED [JP]	Application Withdrawn

# Recording Office Action

Select action type

Normal Action Type

Note Action Type

Action Date \*

Notes

Maecenas feugiat consequat diam. Maecenas metus. Vivamus diam purus, cursus a, commodo non, facilisis vitae, nulla. Aenean dictum lacinia tortor. Nunc iaculis, nibh non iaculis aliquam, orci felis euismod neque, sed ornare massa mauris sed velit. Nulla pretium mi et risus. Fusce mi pede, tempor id, cursus ac, ullamcorper nec, enim.

*Sed tortor. Curabitur molestie. Duis velit augue, condimentum at, ultrices a, luctus ut, orci. Donec pellentesque egestas eros. Integer cursus, augue in cursus faucibus, eros pede bibendum sem, in tempus tellus justo quis ligula.*

- ABC
- DEF
- GHI

body table tbody tr td blockquote p

Option name	Checked			
Address for service not stated		Select	Unselect	Detail
Business address not stated		Select	Unselect	Detail
Company seal/stamp not affixed		Select	Unselect	Detail
Form not signed, named and dated		Select	Unselect	Detail
Full name of individual/firm/bodycorporate not stated		Select	Unselect	Detail
NICE Class not stated		Select	Unselect	Detail
Part of the Register not stated		Select	Unselect	Detail
Representation not visually perceptible	Yes	Select	Unselect	Detail
Specification of goods/services not stated		Select	Unselect	Detail
Statement on use not stated	Yes	Select	Unselect	Detail

# Process History

Events	Status	Frozen By	Freezing				
Type	Date	Description	Notes	Action 1	Action 2		
e-doc	09/01/2008	App: Trade Mark	No content yet				PDF
Action	15/01/2008	Notification of lodgement	Awaiting manual delivery (21/01/2008) .	Details			PDF
Action	25/01/2008	Examiners first report	Awaiting manual delivery (28/01/2008) .	Details			PDF
Action	11/07/2008	Response received		Details			
Action	11/07/2008	Recommendation for acceptance		Details			
Action	21/07/2008 24/09/2008 Journal	Acceptance	Awaiting manual delivery (22/07/2008) .	Details			PDF
Action	24/09/2008	Publication		Details			
User Doc.	02/12/2008	Userdoc:Payment of registration fee (Doc 2008/3491) (User Documents 2008/3491) File:67379 - VODAFONE - VODAFONE GROUP PLC	Processed (16/01/2009)				
User Doc.	02/12/2008	Userdoc:Association of marks (Doc 2008/3499) (User Documents 2008/3499) File:67379 - VODAFONE - VODAFONE GROUP PLC	Processed (16/01/2009)				
Action	15/01/2009	End of opposition period		Details			
Action	16/01/2009	No oppositions filed		Details			
Action	16/01/2009	Registration fee paid		Details			
Action	16/01/2009 24/03/2009 Journal	Registration	Awaiting manual delivery (16/01/2009) .	Details			PDF
Action	16/01/2009	Certificate of registration	Awaiting manual delivery (16/01/2009) .	Details			PDF

# Recording Office Action

Action Type *	PA Formalities objections
Action Date *	PA Acknowledgement of receipt
Notes	PA Acknowledgement of receipt POA SJAR PA Formalities OK PA Withdrawal from filing date

Action Type	Examiners first report
Action Date *	Examiners first report
Notes	Examiners subsequent report Examiners subsequent report (first reminder) Examiners subsequent report (second reminder) Recommendation for acceptance Recommendation for refusal Withdrawal

Action Type	Date is due
Action Date *	Date is due
Notes	Grant of extension of time Response received

# Office Documents

«app\_service\_name»  
«app\_service\_address\_vert»

Mark: «app\_name»  
Class: «app\_rice\_classes»  
Filing: Nbr «app\_file\_number»  
Owner: «app\_owner\_name»  
Our Ref: 7-  
«app\_file\_number»/«action\_use»  
»  
Your Ref:

**Examiners First Report**

Dear Sir/Madam,

We have examined the above mentioned application, and our report follows:

«action\_notes1»

«action\_options»

The report explains the matters which at present prevent your mark from being accepted for registration. If there are any parts of it which you would like us to clarify, please contact this office as indicated above.

To continue with your application you should read our report and respond in writing to the points we have raised. We will consider your reply and if all these points have been resolved then we will recommend that your application be accepted for registration. If there are any points which have not been resolved we will send you a further report.

The Trade Marks Act gives you 6 months from the date on this report in which to overcome the examiner's objections to your application. If your application is not in order by that time you will be sent a reminder notice and given another three months in which to respond. However, unless you apply and pay the prescribed fee for further extensions of time, your application will then lapse.

Yours faithfully,

*Signature*

REGISTRAR OF TRADE MARKS

Parameters Freeze By File Freeze By Userdoc Option List

Final Status Objected, awaiting response

Reason 1  
Reason 2  
Reason 3

Reasons

**Examiners First Report**

Dear Sir/Madam,

We have examined the above mentioned application, and our report follows:

Reason 1  
Reason 2  
Reason 3

The report explains the matters which at present prevent your mark from being accepted for registration. If there are any parts of it which you would like us to clarify, please contact this office as indicated above.

To continue with your application you should read our report and respond in writing to the points we have raised. We will consider your reply and if all these points have been resolved then we will recommend that your application be accepted for registration. If there are any points which have not been resolved we will send you a further report.

The Trade Marks Act gives you 6 months from the date on this report in which to overcome the examiner's objections to your application. If your application is not in order by that time you will be sent a reminder notice and given another three months in which to respond. However, unless you apply and pay the prescribed fee for further extensions of time, your application will then lapse.

Yours faithfully,

*Signature*

REGISTRAR OF TRADE MARKS

# Office Document Templates

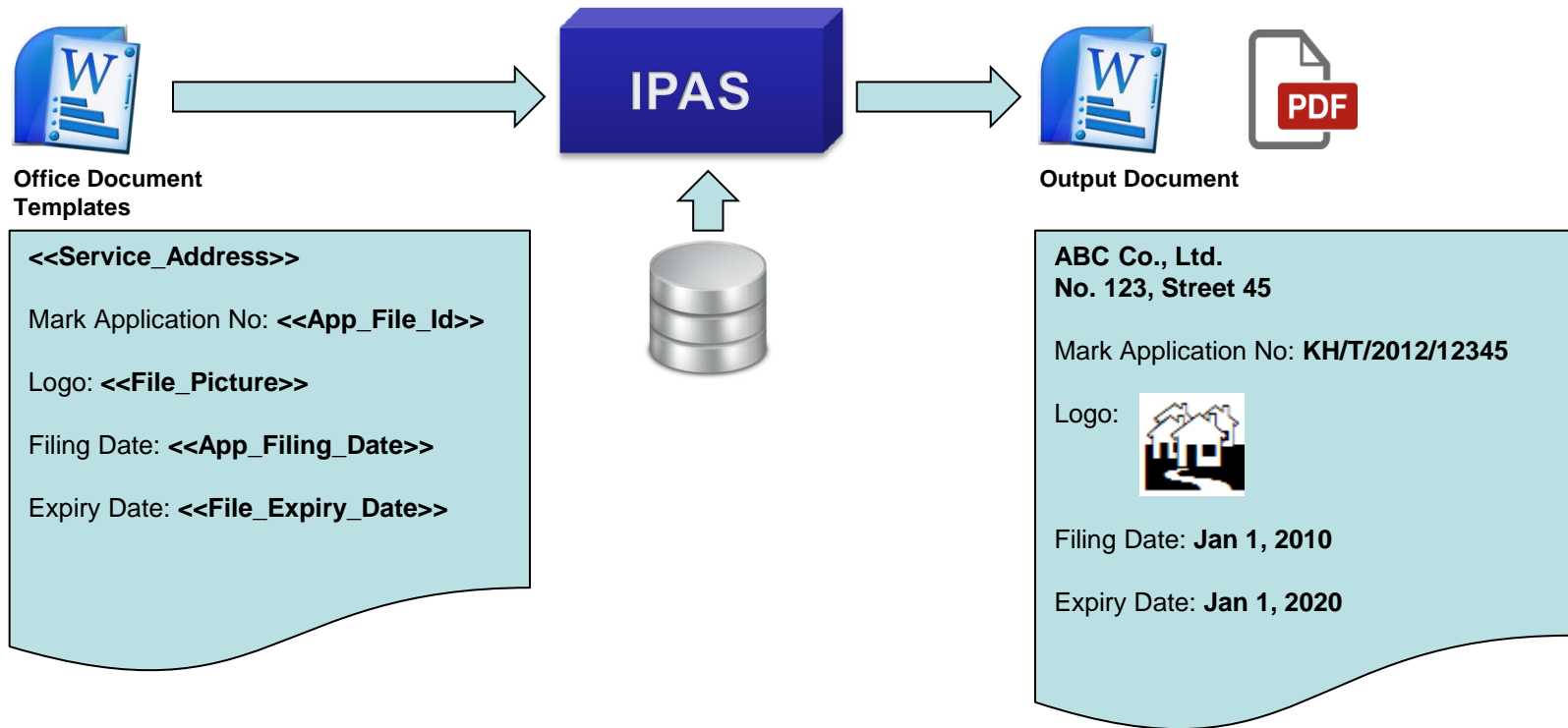

# IPAS Workflows

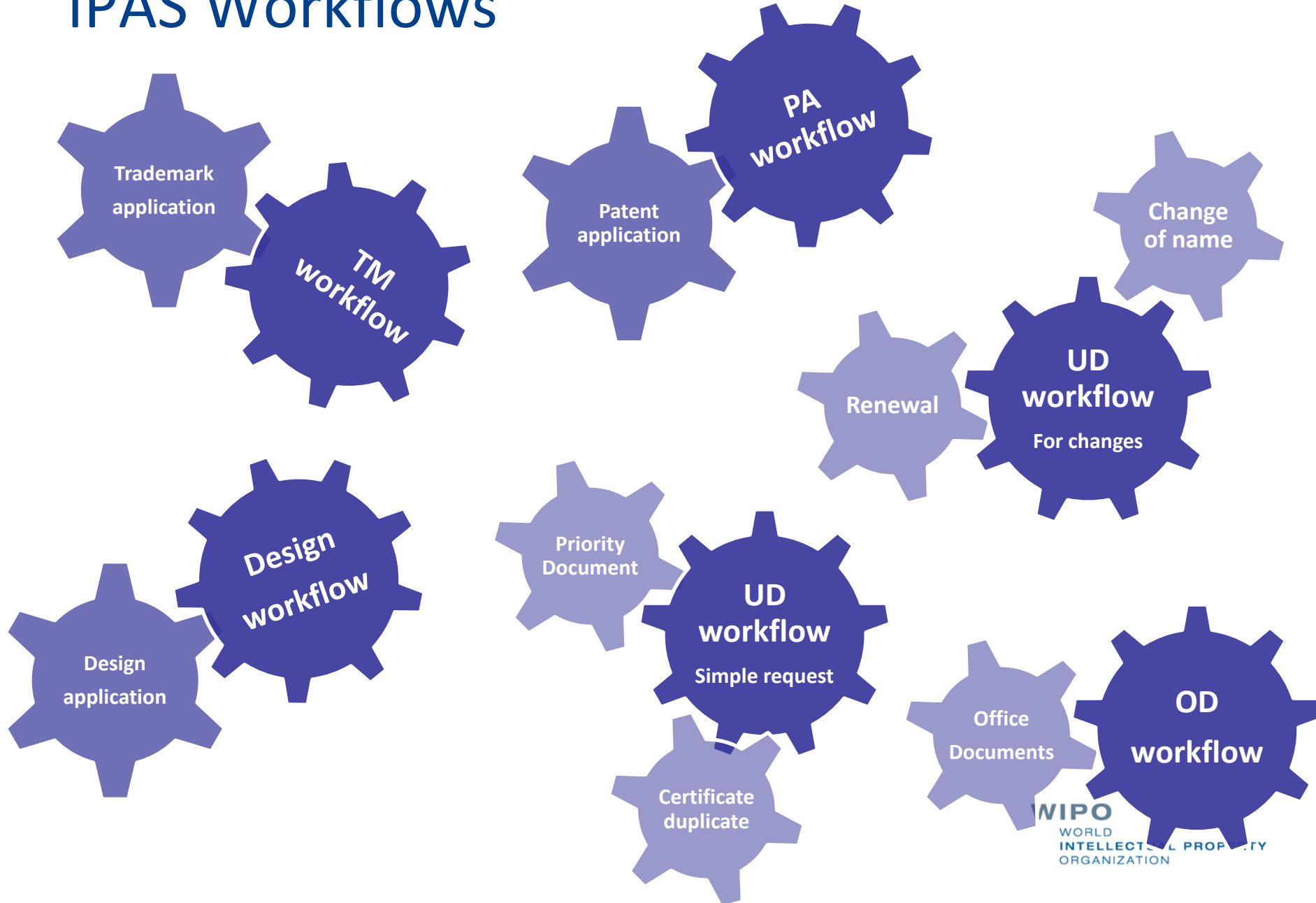



# Trademark Similarities

WIPO  
WORLD INTELLECTUAL PROPERTY ORGANIZATION

IPAS - Industrial Property Administration System

Back | Home | Previous | Next | Edit | Workflow | **Similarities** | Duplicate | New mark | Changes log | Validate | Folder PDF | View POA

## View trademark

Record 5/6

(219) Application Nbr	PG/M/0001/060449
Status	Registered
Last action	Status should be "Registered"
(400) Publication	26/03/1998
Application type	Part A
Sign type	Both name and logo
(541) Mark name	PEPSI
(540) Mark image	



Colour description	-
(526) Disclaimer	ASSOCIATED TRADE MARK

Vienna classes

Category	Division	Section	Description
26	1	0	CIRCLES, ELLIPSES
29	1	0	Group 29-1

# Trademark Similarities

## Search results

Search criteria: Vienna Classes contain 26.1.0 29.1.0 , Vienna classes ignored contain 27.5.1, Nice Classes contain NCL(0)32 , Include reclassified classes, NoveltyDate <= 09/07/1997 00:00:00

83 items found, displaying 76 to 83.

1, 2, 3, 4, 5, 6

Selected	File No	Logo	Filing date	Mark name	Classes	Owner name	Status
<input type="checkbox"/>	PGM/0001/059242		12/12/1995	TUP	NCL(0) 32	The Concentrate Manufacturing Company of Ireland [BM]	Registered
<input type="checkbox"/>	PGM/0001/059380		08/03/1996	ALWAYS COCA COLA	NCL(0) 32	THE COCA-COLA COMPANY [US]	Removed for non-renewal
<input type="checkbox"/>	PGM/0001/059606		12/07/1996	PEPSI	NCL(0) 32	PEPSICO, INC. [US]	Lapsed
<input type="checkbox"/>	PGM/0001/059735		13/09/1996	GB	NCL(0) 32	SOUTH PACIFIC BREWERY LIMITED [PG]	Registered
<input type="checkbox"/>	PGM/0001/059742		17/09/1996	TIGER	NCL(0) 32	ASIA PACIFIC BREWERIES LIMITED [SG]	Registered

# Trademark Similarities

## Edit phonetic similarity list

Reference mark: PEPSI

46 items found, displaying 1 to 15.

◀ 1, 2, 3, 4 ▶▶

Selected	Percent	File nbr	Filing date	Mark name	Classes	Owner name	Status
<input type="checkbox"/>	100	<a href="#">PG/M/0001/002393</a>	16/09/1975	PEPSI	NCL(0) 32	PEPSICO, INC. [US]	Removed for non-renewal
<input type="checkbox"/>	100	<a href="#">PG/M/0001/002394</a>	16/09/1975	PEPSI	NCL(0) 32	PEPSICO, INC. [US]	Registered
<input type="checkbox"/>	100	<a href="#">PG/M/0001/057149</a>	02/06/1992	PEPSI	NCL(0) 32	PEPSICO, INC. [US]	Registered
<input type="checkbox"/>	100	<a href="#">PG/M/0001/059606</a>	12/07/1996	PEPSI	NCL(0) 32	PEPSICO, INC. [US]	Lapsed
<input type="checkbox"/>	80	<a href="#">PG/M/0001/057705</a>	31/05/1993	PEPSI MAX	NCL(0) 32	PEPSICO, INC. [US]	Registered
<input type="checkbox"/>	71	<a href="#">PG/M/0001/055957</a>	16/05/1989	DIET PEPSI	NCL(0) 32	PEPSICO, INC. [US]	Removed for non-renewal
<input type="checkbox"/>	71	<a href="#">PG/M/0001/057138</a>	03/02/1992	DIET PEPSI	NCL(0) 32	PEPSICO, INC. [US]	To be removed
<input type="checkbox"/>	69	<a href="#">PG/M/0001/057150</a>	02/06/1992	PEPSI LIGHT	NCL(0) 32	PEPSICO, INC. [US]	Registered
<input type="checkbox"/>	56	<a href="#">PG/M/0001/002391</a>	16/09/1975	PEPSI-COLA	NCL(0) 32	PEPSICO, INC. [US]	Registered
<input type="checkbox"/>	56	<a href="#">PG/M/0001/002392</a>	16/09/1975	PEPSI-COLA	NCL(0) 32	PEPSICO INC. [US]	Registered
<input type="checkbox"/>	56	<a href="#">PG/M/0001/002395</a>	16/09/1975	PEPSI-COLA	NCL(0) 32	PEPSICO, INC. [US]	Registered
<input type="checkbox"/>	34	<a href="#">PG/M/0001/004301</a>	16/09/1975	SCHWEPPES	NCL(0) 32	ATLANTIC INDUSTRIES [KY]	Registered
<input type="checkbox"/>	34	<a href="#">PG/M/0001/004304</a>	16/09/1975	SCHWEPPES	NCL(0) 32	ATLANTIC INDUSTRIES [KY]	Registered
<input type="checkbox"/>	34	<a href="#">PG/M/0001/004308</a>	16/09/1975	SCHWEPPES	NCL(0) 32	ATLANTIC INDUSTRIES [KY]	Registered
<input type="checkbox"/>	34	<a href="#">PG/M/0001/051998</a>	15/10/1980	SCHWEPPES	NCL(0) 32	ATLANTIC INDUSTRIES [KY]	Registered

# More Features

- Processing Renewals of trademarks and industrial designs
- Processing assignments, merger, change of name and/or address, etc...etc.
- Annuities generation and payment tracking
- Journals/Gazettes preparation
- Pre-Filing Search
- Dossier Tracking
- Productivity Report
- Yearly Statistic Report
- Linkage with electronic document management system

# Key Technologies in IPAS

- JavaEE
- Oracle/Microsoft SQL Server

# Integration with Other Systems

- is made possible by IPAS API and IPAS Web Service

# IPAS

- Extensive customization including:
  - National IP legislation,
  - Workflow processes, legal time-periods and deadlines,
  - Templates of official correspondences, certificates, gazettes,
  - Language, terminology
  
- No programming is required to customize IPAS

# IPAS Madrid Module

- Optional module of IPAS to process Madrid notifications



# IPAS Madrid Module

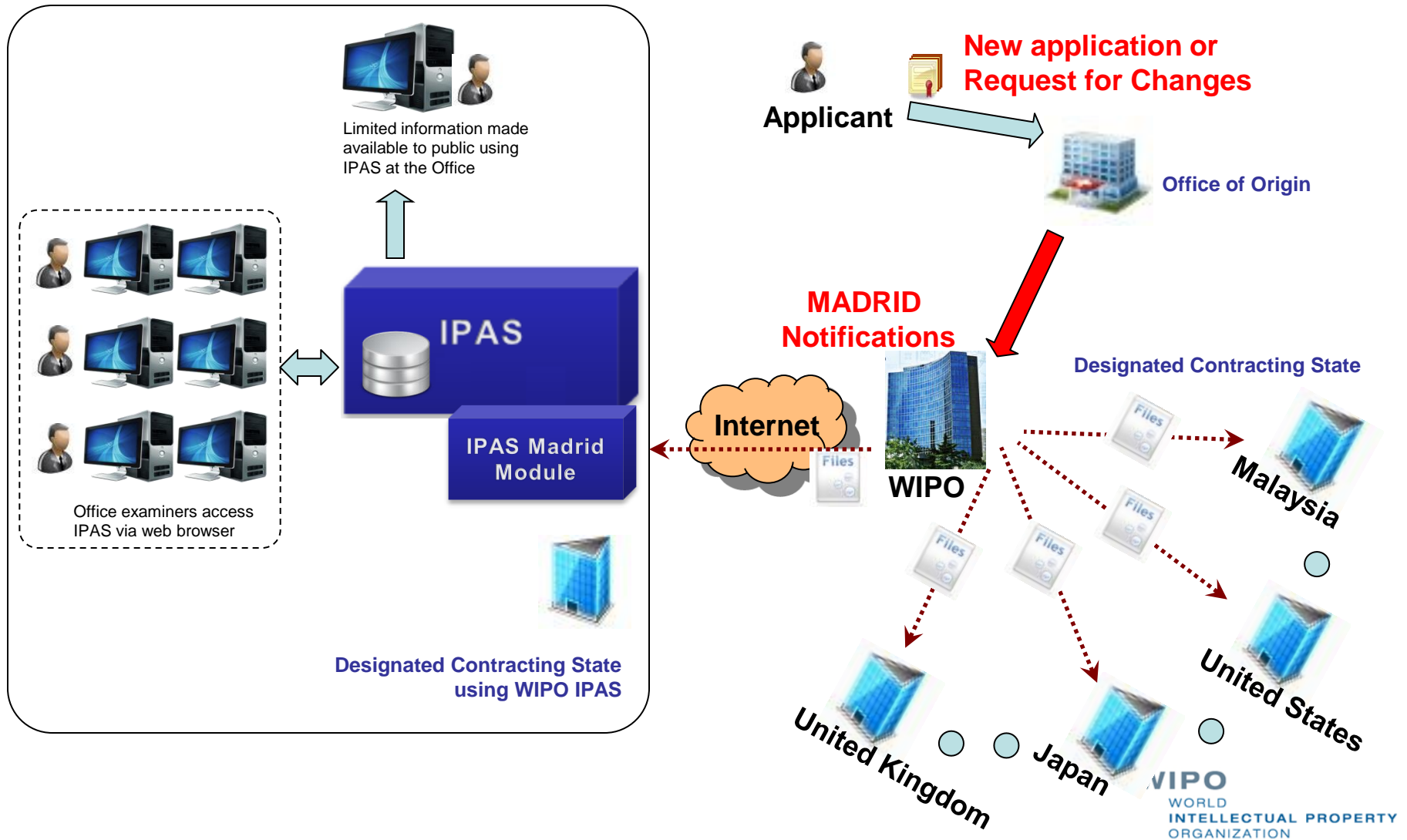



# Madrid Notification

N201101.XML - XML Marker version 1.1

File Edit View Options Navigate Help

Tree Selection Browser

Tree View 0 warning(s)

Table Selection Browser

This Table Selection Browser is empty

Ready

```

NOTDATE="20110120"
<BIRTH
  TRANTYP="ENN"
  INTREGN="1062415"
  OOCN="DE"
  ORIGLAN="1"
  EXPDATE="20201110"
  OFFREF="A 04768/10"
  HOLREF="M32668/WP"
  DOCID="577406501"
  REGRDAT="20110105"

```

Tree Selection Browser

» BIRTH

14 Attributes:

Name	Value
TRANTYP	ENN
INTREGN	1062415
OOCD	DE
ORIGLAN	1
EXPDATE	20201110
OFFREF	A04768/10
HOLREF	M32668/WP
DOCID	577406501
REGRDAT	20110105
NOTDATE	20110120
REGEDAT	20101110
INTREGD	20101110
DESUNDER	P
ART9SEXIES	Y

10 Subtags:

Tag name/Text	Text	Unique Attributes	CLID	Unique Subtags	NAME	ADDRESS	DCPCD
HOLGR		NOTLANG = "1"	693644	3 unique subtags	NAME	ADDRESS	
REPGR			401154		NAME	ADDRESS	
IMAGE		4 unique attributes					
MARDUR	10						
VIENNAGR		VIENVER = "6"		2 unique subtags (10 total occurrences)			
BASICGS		NICEVER = "9"		GSGR (3 occurrences)			
BASGR				BASREGGR			
DESAG							DCPCD (3 occurrences)
DESPG							DCPCD (24 occurrences)
DESPG2							DCPCD (35 occurrences)

# Madrid Module

- Converts Notifications to Applications and User Documents to be processed in IPAS.

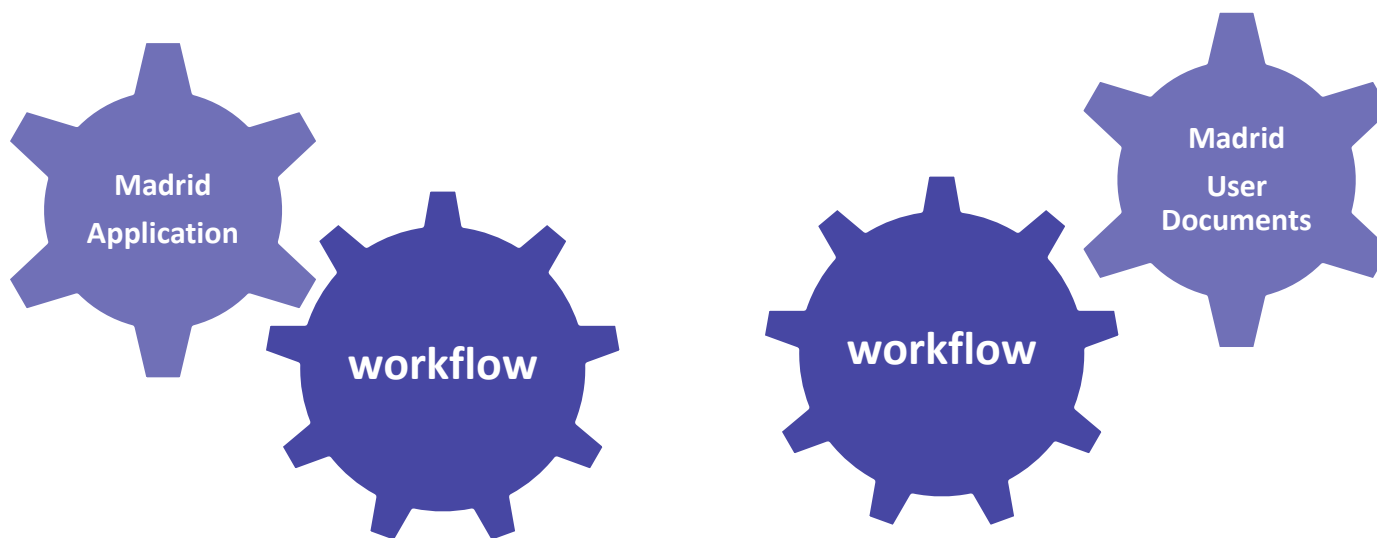

# Madrid Module Deployment Activities

- Define Application numbering (Local number or IRN)
- Define workflow  
(Create new or update existing trademark workflow)
- Define official document templates
- User training

# PCT National Phase Entry Download

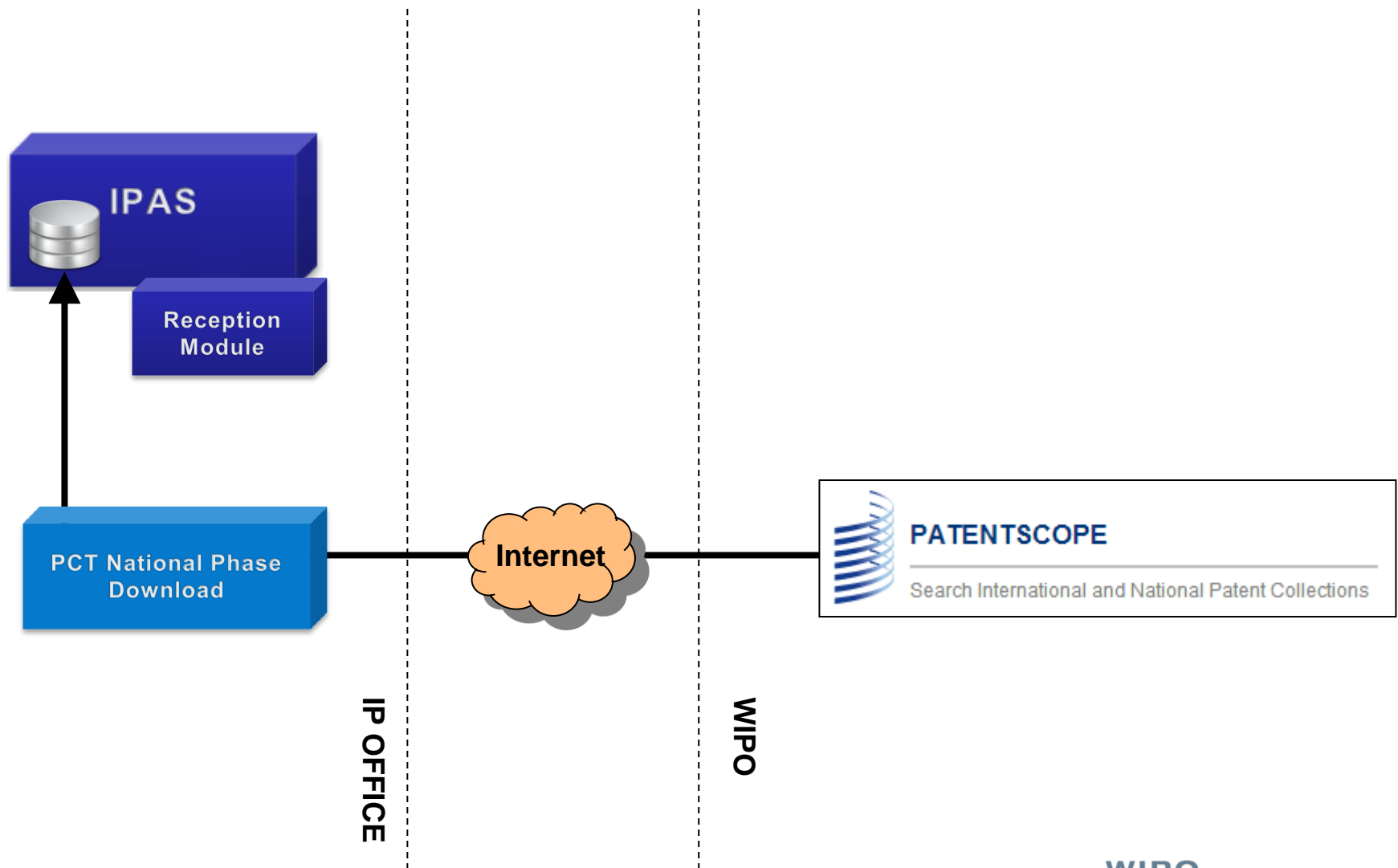

# For more information

■ <https://www3.wipo.int/confluence/display/wipoimd/IP+Office+Support>

WIPO Spaces ▾ 🔍  ? ▾ Log in

IP Office Support

**Pages**

Blog

**SPACE SHORTCUTS**

- [WIPO IPAS Functional and Technical Overview](#)
- [1.- WIPO IPAS Installation and Administration Guide](#)

**PAGE TREE**

- [Accessing restricted pages](#)
- [Automatic notifications of changes to Wiki Space.](#)
- [WIPO IPAS Functional and Technical Overview](#)
- [a.- Software Documentation](#)
- [e.- Support to countries](#)

Pages
 Tools ▾

## IP Office Support

Created by DB Admin, last modified by Gabriel BERLICKI on Mar 13, 2014

This wiki space is intended to provide up to date information relating to WIPO systems that are developed for and deployed in national Intellectual Property Offices. The wiki space contains documentation on the different products, as well as specifications for new features and, for authorized users, the software repository installation and change documentation.

[WIPO IPAS Functional and Technical Overview](#)

[Accessing restricted pages](#)

[Automatic notifications of changes to Wiki Space.](#)

**Live search @ IP Office Support Wiki Space:**

**Recently updated:**

- [WIPO IPAS FAQ](#)  
Oct 09, 2015 • updated by Yee Moon Andrew TU • view change
- [How to create a manual stored procedure based automatic action in the case of non-payment of expiring annuity for patent application](#)  
Oct 09, 2015 • updated by Yee Moon Andrew TU • view change
- [Generation of Electronic Signature for Office Document in IPAS 3.1.1](#)  
Sep 28, 2015 • updated by Yee Moon Andrew TU • view change
- [WIPO IPAS FAQ](#)  
Sep 14, 2015 • updated by Daniel CHENG • view change

[Show More](#)